

Downlight

COB1-DWR96-12W

Picture



Description

Type	LED Downlight
Connection	Wire

Electrical Parameters

Gr. Power	12W ±5%
InputVoltage	AC200-240V
Driver	Lifud
Dimmable	Not dim.

Lighting Parameters

Beam Angle	20/38/55/110
Colors	3000°K; 4000°K; 6000°K
Lumens	1100-1500
CRI	90Ra

Structure Parameters

Fixture Color	White; Black
Cover	Clear
Dimensions	dia96*63mm (hole75-85)

Protection Parameters

Rating	IP33/UGR<19
Electrical Class	Class II
Lifetime	LM79/LM80
Warranty (Years)	5

Options

Dimmable	Triac <input checked="" type="checkbox"/> 0-10V <input type="checkbox"/> 1-10V <input checked="" type="checkbox"/> DALI <input checked="" type="checkbox"/>
CRI	>90Ra <input type="checkbox"/> >92Ra <input type="checkbox"/> >95Ra <input type="checkbox"/> >98Ra <input type="checkbox"/>
Other	Optional: 110°; special CCT; IP54; Silver housing

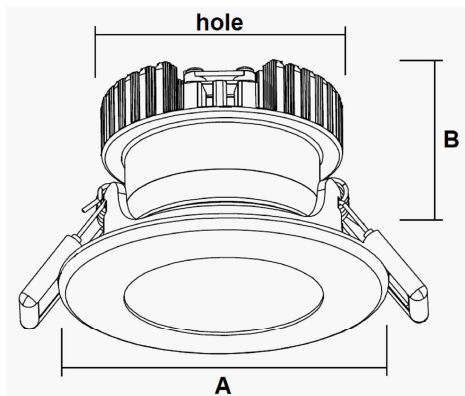

Sizes in mm

Packing

UnitVolum (CBM)	0,0016351875
Unit GW (kg)	0,427
Qty per carton	48